

Network Intelligent Speed Dome Camera

USE/INSTALLATION

SUPER SPEED DOME

USER INSTRUCTION

Special Declaration

Before connecting and using this product, please read these instructions carefully and keep it for references in the future.

This manual might be not accurate technically or contains some minor type errors. The contents in this manual about production description and program might be updated without notice. Updated contents will be added in the new version. We will change or upgrade the products or program any time.

Careful Transport

During transport, custody and installation should prevent damage to this product by weight, severe vibration and soak.

Power Supply, Video Cable and Control Cable

For power supply cable, video cable and control cable, please adopt shielded cable and independent wiring, can not mix with other cables.

Electric Safety

Should obey all kinds of electric standard when using speed dome camera, make sure signal cable keep enough distance (at least 50m) with high voltage equipment or cables. If it is possible, please take lightning and surge protection measures.

Clean

When clean camera housing, please use dry soft cloth to wipe, If it is very dirty, please use neutral cleanser to wipe lightly. Do not use strong or grind cleanser to prevent its housing from scratching.

Strictly Sealed

Prevent liquid or other things from getting into speed dome housing, else it will cause permanent damage.

Please do not use camera beyond limited temperature and humidity

Speed dome camera working temperature:-25℃ to 50℃, humidity less than 90%.

Please do not install camera near air conditioner's outlet

- * Under following situation, lens will be fogged because of condensation.
- * Use under the environment where the temperature rise and down frequently which caused by the air conditioner power on and off frequently.
- * Use under environment which can make glass fog.
- * Use under environment full with smoke or dust.

Please do not make camera toward to strong light source, such as the sun

Toward camera to strong light source for a long time will damage the color filter on CCD, then it will make image lose color.

CONTENTS

Chapter 1 Product Overview	3
1.1 Product Features.....	3
1.2 Speed Dome Parameter.....	4
1.3 Structure Dimension.....	5
Chapter 2 Installation	6
2.1 Install Instruction.....	6
2.2 Install Method.....	6
2.3 Baud Rate Setup.....	8
2.4 ID Setup.....	8
2.5 Power Supply And Network Cable Connection.....	10
2.6 Connecting Method.....	10
2.7 Connection Diagram Instructions.....	11
2.8 Typical Wiring Diagram.....	11
Chapter 3 Basic Operation	12
3.1 Power On Self-test.....	12
3.2 Preset Setting.....	12
3.3 Preset Call.....	12
3.4 Function Realization By Preset.....	13
3.5 Patrol Setting.....	17
Chapter 4 Appendix	18
4.1 Simple Troubleshooting.....	18
4.2 Clean The Transparent Cover.....	18
4.3 Lightning And Surge Protection.....	19
4.4 Pressing Line Method And Line-sequential Of Network Cable.....	20

1.1 Product Features

Stronger Intelligent Function

- Support WEB access to visit and configure the devices, support OSD, support real time video transmission, support motion detection.
- Built in network code function, support ONVIF protocol.
- Support JPEG capture picture, unified client remote control monitoring software and easy connect the brand NVR.
- 10/100M auto adaptive, support RTSP/ FTP/PPPOE/DHCP/DDNS/NTPS and so on network protocol.

PTZ Control

- Pan 360 °, continuous rotation; Tilt 90°, no monitoring blind spot.
- Auto adjust PTZ speed according to the zoom function.

Night vision

- Auto open infrared lamps according to the light.
- Auto adjust the brightness of infrared lamps based on the lens far or near.
- Adopt the forth infrared array light technology coordinate with intelligent dimming technology, better night vision.

Chapter 1 Product Overview

1.2 Speed Dome Parameter

Electric			
Rated voltage	DC12V 4A \pm 10%	Power Consumption	Max 15W in day-time Max 30W in night
Decoder	Built in	IR distance	100m~120m
Operate			
Pan Range	360° endless	Tilt rotate	90°
High Speed	Pan 0.6° ~ 200° /s Tilt: 0.8° ~ 75° /s	Preset	220
Middle Speed	Pan 6° ~ 30° /s Tilt: 4° ~ 17° /s	Monitoring Method	Preset/Patrol/Pan Scan
10/100M auto adaptive;support RTSP/FTP/PPPPOE/DHCP/DDNS/NTP/UPnP and so on network protocol,support WEB,support OSD,support real time video transmission,support motion detection, support JPEG capture picture; support unified client remote control monitoring software, easy connect brand NVR in the market.			
Environment			
Operate Environment	Outdoor:-20 ~ +60℃ Indoor: -10 ~ +50℃	Protection Grade	IP66(outdoor speed dome camera)
Environment Humidity	0~95% no condensation		
Physical			
Installation Method	Wall Mount or Ceiling Mount		

1.3 Structure Dimension

Dome Camera

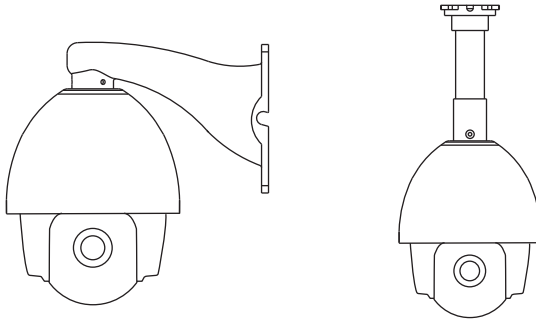

Dome Camera Brackets

Wall Bracket

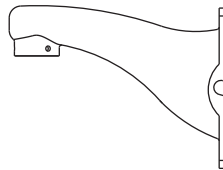
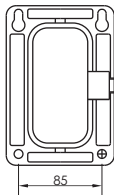

Ceiling Bracket

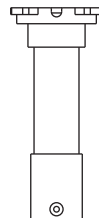
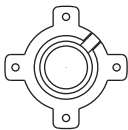

2.1 Installation Instruction

Prepare before installation

Installation under professional technician and obey related rules in order to avoid troubles.

Confirm all accessories complete or not, make sure the speed dome camera application place and installation method meet the requirement.

Wall mount/ceiling mount speed dome camera composed by bracket, zoom module and transparent cover and other parts.

Speed dome camera has been finished the installation test when export, user can do installation directly.

2.2 Installation Method

L type speed dome camera installation method

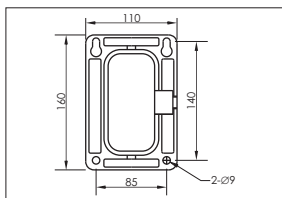

Wall Mount Bracket

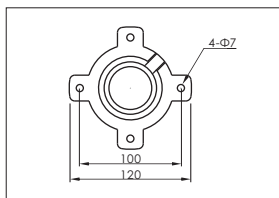

Ceiling Mount Bracket

Step 1- Draw positioning holes

Take out bracket from package box, mark the hole's position on wall or ceiling based on mount bracket bottom 4pcs installation holes.

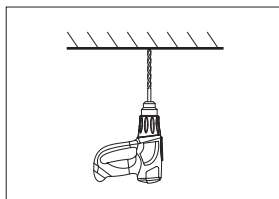
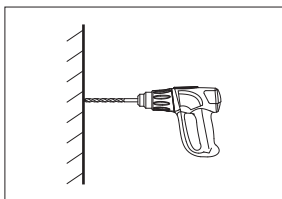

Step 2- Drill holes and put expansion screws in

Drill 4pcs expansion screw's installation holes at pre-marked position, then put 4pcs expansion screws in.

Note: Please bring expansion screws own.

Chapter 2 Installation

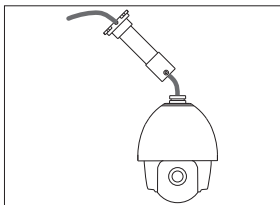
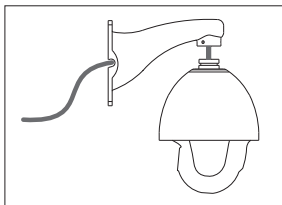

- Step 3 - Lead cable through wall mount bracket**
Lead the cable through wall mount bracket hole.

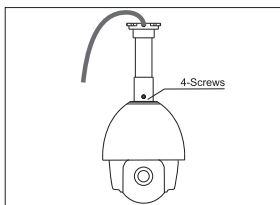
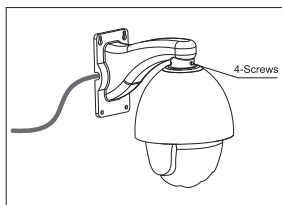

- Step 4 - Connect speed dome camera and wall bracket.**
Put speed dome camera connection port into the bracket hole and screw 4pcs hexagon screws into the corresponding screw holes.

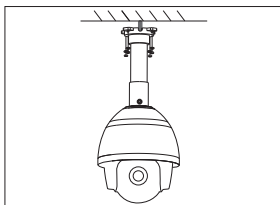
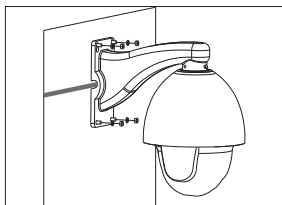

- Step 5 - Fix the speed dome camera**
Lead the cable out from the wiring port, then fix it on the wall by using 4 screws. Seal the wiring port of the bracket by using silicon sealant.

- Step 6 - Cable connection**
Please refer to section of six of this chapter- Connection method.

- Step 7- Tear off protection film**
Tear off protection film of transparent cover

Note: Please take care of the transparent cover.

2.3 Baud Rate Setup

Baud rate and corresponding DIP status as below:

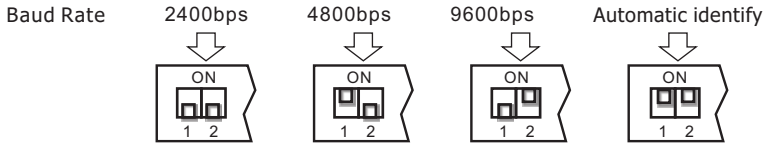

RS485 control bus need all device which connect to it shall be in parallel mode, and each end of the system shall be connected to a 120Ω resistor. Our speed dome has a 120Ω resistor in it, you need only set it up through dip switch SW2, put the 4th switch on, then the resistor is connected, details as below:

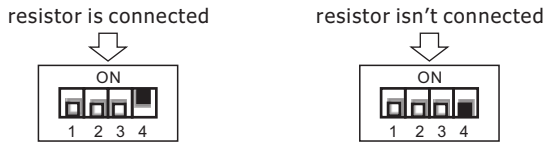

2.4 ID Setup

ID setup (address code setup obey binary rules)
 address code shall be set through 8 DIP switch (SW1).
 Keyboard control speed dome through communication bus, one keyboard can control max. 255pcs speed dome camera, each speed dome camera has its own address code, user can set address code through 8 DIP switch, details as below:

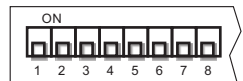

Address	SW1 Switch Setup							
	SW1-1	SW1-2	SW1-3	SW1-4	SW1-5	SW1-6	SW1-7	SW1-8
1	ON	OFF	OFF	OFF	OFF	OFF	OFF	OFF
2	OFF	ON	OFF	OFF	OFF	OFF	OFF	OFF
3	ON	ON	OFF	OFF	OFF	OFF	OFF	OFF
4	OFF	OFF	ON	OFF	OFF	OFF	OFF	OFF

Chapter 2 Installation

5	ON	OFF	ON	OFF	OFF	OFF	OFF	OFF
6	OFF	ON	ON	OFF	OFF	OFF	OFF	OFF
7	ON	ON	ON	OFF	OFF	OFF	OFF	OFF
8	OFF	OFF	OFF	ON	OFF	OFF	OFF	OFF
9	ON	OFF	OFF	ON	OFF	OFF	OFF	OFF
10	OFF	ON	OFF	ON	OFF	OFF	OFF	OFF
11	ON	ON	OFF	ON	OFF	OFF	OFF	OFF
12	OFF	OFF	ON	ON	OFF	OFF	OFF	OFF
---	---	---	---	---	---	---	---	---
254	OFF	ON	ON	ON	ON	ON	ON	ON
255	ON	ON	ON	ON	ON	ON	ON	ON

2.3 Power supply and network cable connection

Power supply connection

Note: Please carefully check the rated voltage and power supply, rated voltage and current as below:

Rated Voltage	Rated Voltage Range	Current
DC12V	±10%	4A

Network connection

Network speed dome camera can connect with computer, NVR monitoring device through router or switch or other network devices by network parallel cable; also can connect with computer, NVR by network crossover cable.

Note: 1) Network cable output distance less than 100m.

2) Network parallel and network crossover connection method details please refer to appendix-Network cable connection method.

3) IP address of speed dome camera in Monitoring network should not be the same.

2.4 Connection Method

Connection method as below program, order to connect network cable, power supply cable(connect order based on the keyboard model number, here just give one example). Details as below:

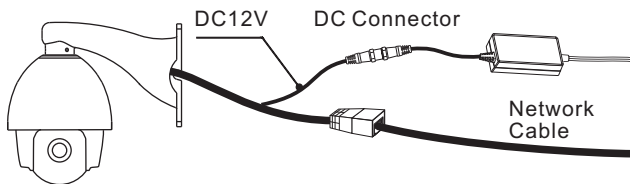

Chapter 2 Installation

2.5 Connection Diagram Instructions

Port Mark	Port Instruction	Connection Instruction
Power Supply Cable	DC12V Power Input	Connect DC12V/4A Power Supply
Network Port	Connect Network	1: TX+ 2: TX- 3: RX+ 6: RX-

2.6 Typical Wiring Diagram

LAN Connection

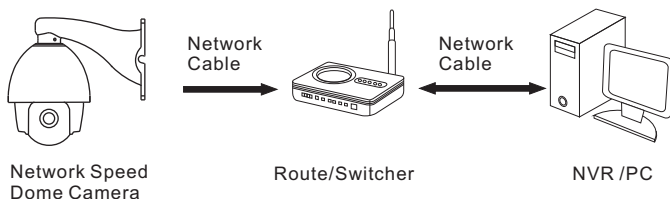

WAN Connection

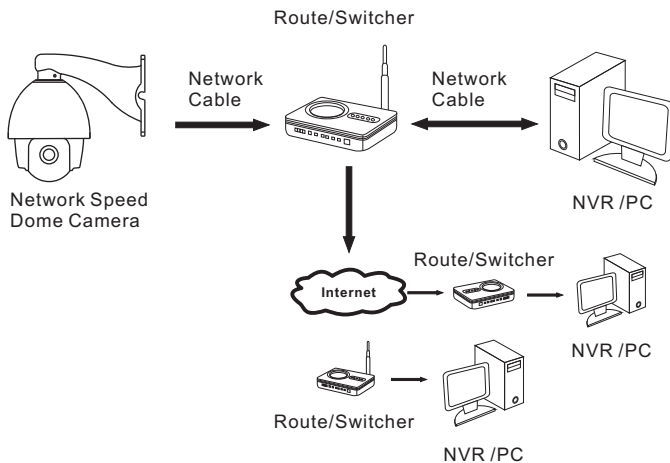

The operation methods of different system platforms are not completely same. Generally, it is subject to the user manual provided by the manufacturer. There will be specific requirements and operation methods in different conditions. Please contact the supplier for required information.

3.1 Power-On Self Test

When the power is on, camera will pan / tilt rotate automatically, which is to make sure camera works well by self test. Configuration of the IP camera can be done by Web,Client or NVR(Please find the details in CD, << Client User Manual>>). Pan / Tilt rotation, presets call, and specific functions can be controlled by PTZ control interface.

3.2 Preset Setting

Following is the steps:

- (1) Adjust to picture of camera through PTZ control interface.
- (2) Choose preset number in control interface, click "Add", camera saves the parameters of preset scenario.

3.3 Preset Call

Following is the steps:

- (1) Choose preset number in control interface, click call;
- (2) Camera moves to preset position immediately, the zoom of lens will change to preset parameter automatically

Chapter 3 Basic Operation

3.4 Function Realization By Preset

Adopting the method of double-layer presets, achieve all the functions of the camera by preset call, Specific correspond <<Preset Function Table of General Function>> and <<Preset Function of Specific Function>>.

Call mode: call mode is on in general preset of call, specific function is achieved by the mode of preset call; for example: [92] + [SHOT] + [1] + [SHOT], which is to call patrol 1;

Setting mode: setting mode is on in general preset of setting, specific function is achieved by the mode of preset call; for example: [92] + [PRESET] + [1] + [SHOT], which is to set patrol 1.

Preset Function Table of General Function

General Function	Preset	Remarks
IR	90	
Zoom module	91	
Patrol scan	92	
Pattern scan	93	
PTZ control	94	
Menu	95	Support dome menu
System Setting	96	
Reservation	97	
High speed auto scan	98	
Low speed auto scan	99	

Preset Function Of Specific Function

General Function	Preset No.	Call Mode	Setting Mode	Remarks
IR Function only support IR speed dome camera	1	Auto ON/OFF		
	2	Forced ON		
	3	Force OFF		
	11	High Sensitivity		
	12	Middle Sensitivity		
	13	Low Sensitivity		
Zoom Module Setting	1	IRCUT - ON		
	2	IRCUT - OFF		
	3	IRCUT - AUTO ON		
	4	IRCUT - AUTO OFF		
	50	Zoom Camera Automatic Diagnosis		
	51	SONY		
	52	HITACHI		
	53	SAMSUNG		
	54	HIK		
	55	MYTECH		
	56	LG		
	57	LG-XDI		
	58	CNB		
	59	CNB 36 x Optical Zoom		

Chapter 3 Basic Operation

Zoom Module Setting	60	GV		
	61	SWELL		
	62	BQL		
	63	WIT		
	80	Enter module menu		Module support OSD function
	81	Confirm function in OSD menu		
Patrol Scan	1	Call patrol 1	Patrol 1 setting start	
	2	Call patrol 2	Patrol 2 setting start	
	3	Call patrol 3	Patrol 3 setting start	
	4	Call patrol 4	Patrol 4 setting start	
	5	Call patrol 5	Patrol 5 setting start	
	6	Call patrol 6	Patrol 6 setting start	
	7	Call patrol 7	Patrol 7 setting start	
	8	Call patrol 8	Patrol 8 setting start	
	9	Patrol setting end		
	10	Patrol time setting(5-240sec.)		
	11	Patrol speed setting(1-63)		
Pattern Scan	1	Call pattern 1	Pattern 1 setting start	
	2	Call pattern 2	Pattern 2 setting start	
	3	Call pattern 3	Pattern 3 setting start	
	4	Call pattern 4	Pattern 4 setting start	
	5	Pattern setting end		

PTZ Control	1-8	Park preset 1-8		
	9-16	Park patrol 1-8		
	17-20	Park pattern 1-4		
	21	Park auto scan		
	22	Park AB lines scan		
	30	Park time 0(off)		
	31	Park time 10s		
	32	Park time 30s		
	33	Park time 60s		
	41	A line-scan setting		
	42	B line-scan setting		
	43	High speed line-scan start		
	44	Middle speed line-scan start		
	45	Low speed line-scan start		
	46	Inner arc line-scan		
	47	Outer arc line-scan		
	50	Open autotracking		support speed dome camera with autotracking
	51	Off autotracking		
	52	Open zoom self-adaption		support IP speed dome camera with autotracking
	53	Off zoom self-adaption		
System Setting	Continuous call 10,12,14	Restore factory settings		
	30	On/off Auto-flip		Support flip Dome Camera

Chapter 3 Basic Operation

3.5 Patrol Setting

Start patrol order “set preset 92+ call corresponding preset of patrol number”, then add preset “call preset”, every patrol path can add Max. 32 presets. After adding, save the setting by “set preset 92 + call preset 9”

The setting of preset standing time: “set preset 92 + call preset 10 + call corresponding preset of time”.

The setting of preset running speed in patrol: “set preset 92 + call preset 11 + call corresponding preset of speed;

[For example] add 1-4 presets in patrol 1, standing time 30s, speed 40, follow the instructions below:

Add preset in patrol path:

- (1) Set preset 92, call preset 1, start patrol 1 setting.
- (2) Call preset 1, add preset 1 to patrol 1.
- (3) Call preset 2, add preset 2 to patrol 1.
- (4) Call preset 3, add preset 3 to patrol 1.
- (5) Call preset 4, add preset 4 to patrol 1.
- (6) Call preset 92, then call preset 9, save patrol 1.

The setting of preset standing time in patrol:

- (1) Set preset 92, then call preset 10, start the setting of preset standing time.
- (2) Call preset 30, set standing time to 30s.

The setting of preset running speed in patrol:

- (1) Set preset 92, then call preset 11, start the setting of preset running speed.
- (2) Call preset 40, set preset running time to 40.

4.1 Simple Troubleshooting

Failure Mode	Parts For Checking	Possible Cause	Solution
No actions and no images after power on	External electricity	Power supply is abnormal	Replace
		Main board exists problems	Replace
There is image, but camera can't self test after power on	Motor is abnormal	Mechanical fault	Whether something get stuck
	The swing of camera	Very oblique	Adjust
		Power is not enough	Use the right power supply
		Main board exists problems	Replace
Camera can self test after power on, but no image	No connect cable between power board and connecting plate	Disconnected	Connect again
	Network cable	Disconnected	Connect well
		Cable is too long	The normal length is 100m
		IP addresses conflict	Change IP address
		Line-sequential of network cable is wrong	Equivalent devices use crossover cable; Incoordinate devices use parallel cable
There is image, camera can self test after power on, but can't control	Client, Web configuration	The settings of PTZ address, protocols, and baud rate	PTZ address, protocols, and baud rate must correspond with the information of camera dial code
Image is faint		Camera is in the status of manual focus	Set the zoom module to auto focus
	Transparent protective cover	It is dirty	Clean the cover

4.2 Clean The Transparent Cover

The transparent cover must be cleaned regularly to make imaging clear. Please be careful when you clean it. Don't touch the transparent cover directly; the acidic perspiration stains may corrode the surface coating of this transparent cover. Hard objects may scratch the transparent cover, which will lead to faint imaging.

Please use soft dry cloth or other substitutes to clean it.

If dirty is serious, you can use neutral cleanser. It also can be cleaned by any senior furniture cleaning products.

Chapter 4 Appendix

4.3 Lighting Protection, Surge Protection

Outdoor speed dome camera must consider thunder-proof and surge immunity. On the premise of guaranteeing electrical safety, we can take following lightning protection measures:

- At least keep 50m distance between signal transmission line and high voltage equipment or high voltage cable.
- Outdoor wiring under the eaves.
- For open field, adopt seal steel pipe buried wiring way, and adopt one-point earthing with the steel pipe. Do not adopt aerial wiring.
- It need to add extra high-frequency thunder-proof device and lightning rod in strong thunderstorms area or high inductive voltage region (such as high voltage substation).
- Thunder-proof and grounding design of Exterior installation and circuit must be in accordance with building lightning proof requirements; It must meet national standard and industry standard.
- System must be equipotential grounding. Grounding device must meet anti-jamming and electric safety dual requirements. The connection with strong electrified wire netting can't be short connection or mixed connection. When system is in the condition of single-phase grounding, ground impedance is less than 4Ω , ground wire cross-section area must be more than 25 mm^2 .

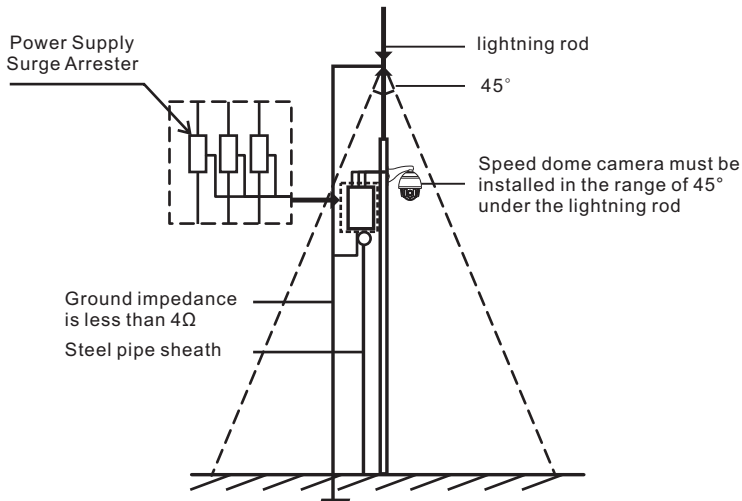

4.4 Pressing Line Method And Line-sequential Of Network Cable

There are two kinds of network cable: crossover cable and parallel cable.

Crossover cable: one end uses the standard of 568A, the other end uses the standard of 568B.

Parallel cable: Both the two ends use 568A or 568B (568B is mostly adopted).

The standard of 568A: green-and-white, green, orange-and-white, blue, blue-and-white, orange, brown-and-white, brown.

The standard of 568B: orange-and-white, orange, green-and-white, blue, blue-and-white, green, brown-and-white, brown.

If the two equipments are incoordinate, use parallel cable to connect. For example, connect PC to the router or switch.

If the two equipments are equivalent, use crossover cable to connect. For example, connect PC to PC.

